



---

## INSTRUCTION MANUAL

VHF LAND MOBILE RADIO

**IC-F1020**

UHF LAND MOBILE RADIO

**IC-F2020**

---

This device complies with Part 15 of the FCC Rules. Operation is subject to the condition that this device does not cause harmful interference.

---

**SmarTrunk II™  
Compatible**

---

**Icom Inc.**

---

## IMPORTANT

---

**READ ALL INSTRUCTIONS** carefully and completely before using the transceiver.

**SAVE THIS INSTRUCTION MANUAL** — This instruction manual contains important operating instructions for the **IC-F1020** and **IC-F2020 LMR TRANSCEIVERS**.

---

## EXPLICIT DEFINITIONS

---

The following explicit definitions apply to this manual.

WORD	DEFINITION
<b>⚠ WARNING</b>	Personal injury, fire hazard or electric shock may occur.
<b>CAUTION</b>	Equipment damage may occur.
<b>NOTE</b>	If disregarded, inconvenience only. No risk of personal injury, fire or electric shock.

**SmarTrunk II™** is a Trademark of SmarTrunk Systems, Inc.

---

## CAUTIONS

---

**⚠ WARNING! NEVER** connect the transceiver to an AC outlet. This may pose a fire hazard or result in an electric shock.

**NEVER** connect the transceiver to a power source of more than 16 V DC such as a 24 V battery. This connection will ruin the transceiver.

**NEVER** cut the DC power cable between the DC plug and fuse holder. If an incorrect connection is made after cutting, the transceiver might be damaged.

**NEVER** place the transceiver where normal operation of the vehicle may be hindered or where it could cause bodily injury.

**NEVER** allow children to touch the transceiver.

**NEVER** expose the transceiver to rain, snow or any liquids.

**DO NOT** connect the transceiver to a power source using reverse polarity. This connection will not only blow fuses but also may damage the transceiver.

**USE** supplied microphone only. Other microphones have different pin assignments and may damage the transceiver.

---

# TABLE OF CONTENTS

---

IMPORTANT .....	i
EXPLICIT DEFINITIONS .....	i
CAUTIONS .....	i
TABLE OF CONTENTS .....	ii
<b>1 PANEL DESCRIPTION .....</b>	<b>1–5</b>
■ Front panel .....	1
■ Programmable function keys .....	2
■ Function display .....	5
<b>2 OPERATION .....</b>	<b>6–8</b>
■ Turning power ON .....	6
■ Channel selection .....	6
■ Receiving and transmitting .....	7
◇ Transmitting notes .....	7
◇ DTMF transmission .....	8
<b>3 CONNECTION AND INSTALLATION .....</b>	<b>9–12</b>
■ Rear panel and connection .....	9
■ Unpacking .....	10
■ Mounting .....	11
■ Separation .....	11
■ Optional UT-105 installation .....	12
<b>4 OPTIONAL SmarTrunk II™ OPERATION .....</b>	<b>13–15</b>
■ SmarTrunk II™ and conventional modes .....	13
■ SmarTrunk II™ operation .....	13
<b>5 OPTIONS .....</b>	<b>16</b>

---

**DO NOT** use or place the transceiver in areas with temperatures below  $-30^{\circ}\text{C}$  ( $-22^{\circ}\text{F}$ ) or above  $+60^{\circ}\text{C}$  ( $+140^{\circ}\text{F}$ ) or, in areas subject to direct sunlight, such as the dashboard.

**AVOID** operate the transceiver without running the vehicle's engine. The vehicle's battery will quickly run out if the transceiver is in transmission while the vehicle's engine OFF.

**AVOID** placing the transceiver in excessively dusty environments.

**AVOID** placing the transceiver against walls. This will obstruct heat dissipation.

**AVOID** the use of chemical agents such as benzine or alcohol when cleaning, as they damage the transceiver surfaces.

**BE CAREFUL!** The transceiver will become hot when operating continuously for long periods.

*For U.S.A. only*

**CAUTION:** Changes or modifications to this transceiver, not expressly approved by Icom Inc., could void your authority to operate this transceiver under FCC regulations.

# 1

## PANEL DESCRIPTION

### ■ Front panel

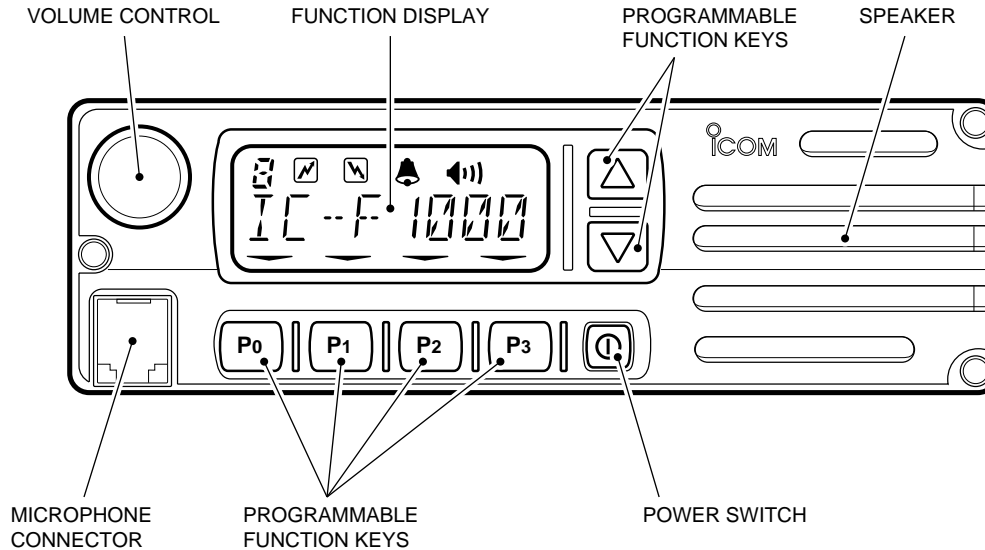

## VOLUME CONTROL

Adjusts the audio output level.

- Minimum audio level (when setting control at maximum counterclockwise) is pre-programmed.

## POWER SWITCH

Turns the power ON and OFF.

- The following functions are available at power ON as options:
  - Automatic scan start
  - Password prompt

## MICROPHONE CONNECTOR

Connects the supplied microphone or optional DTMF microphone for SmarTrunk II™ operation here.

**NEVER** connect other microphones. The pin assignments may be different and the transceiver may be damaged.

## MICROPHONE

The supplied microphone has a PTT switch and a hanger hook.

- The following functions are available when the microphone is hung on or released from the microphone hanger:
  - Automatic scan start when hung.
  - Automatic priority channel selection when released.
  - Turns OFF and ON the monitor function when hung or released respectively.

## ■ Programmable function keys

The following functions can be assigned to programmable function keys. Assigned function names can be affixed to the LCD using supplied stickers.

### CHANNEL UP AND DOWN KEYS

**CH UP**

- Select an operating channel

- Select a bank after pushing the **[BANK S]** key.

**CH DN**

- Select a DTMF channel after pushing the **[DTMF]** key.

- Select a scan group after pushing and holding the **[SCAN]** key.

### BANK UP AND DOWN KEYS

**BK UP**

- Select a bank (a group of 16 (or multiples of) channels).

**BK DN**

- This function may be available for the optional 160 channel type only.
- When the optional UT-105 is installed, push one or more times to select a channel bank for conventional channels or SmarTrunk II™ channels.

# 1 PANEL DESCRIPTION

## BANK SELECT KEY

**BK S** Sets the [CH UP] and [CH DN] keys as bank up/down keys.

- Push this key, then push the [CH UP] or [CH DN] to select the desired bank.
- When the optional UT-105 is installed, push one or more times to select a channel bank for conventional channels or SmarTrunk II™ channels while pushing [BK S].

## OPERATING CHANNEL KEYS

**CH 1** Select an operating channel directly without the [CH UP] and [CH DN] keys.

**CH 2**

**CH 3**

**CH 4**

## SCAN START/STOP KEY

**SCAN** Push this key to start scanning; and push again to stop.

 **NOTE:** Hung the microphone to the microphone hanger to operate scanning. When release the microphone, scan will be canceled.

Push and hold this key to indicate the scan group, then push [CH UP] or [CH DN] to select the desired group.

## SCAN TAG KEY

**TAG** Adds or deletes the selected channel to the scan group.

- “” appears above the [TAG] key when the channel belongs to the scan group.

## PRIORITY CHANNEL KEY

**PRI A** Selects a priority A or priority B channel with each push.

**PRI B**

## LOCK KEY

**LOCK** Electronically locks all programmable keys except the [MONI] and [EMER] keys.

## MONITOR KEY

**MONI** Activates the following functions on each channel independently:

- Push and hold the key to unmute the channel (audio is emitted).
- Push the key to toggle the monitor function ON and OFF (or ON only or OFF only depending on the pre-setting).

## OUTPUT POWER SELECTION KEY

**HIGH** Selects the transmit output power temporarily or permanently depending on the pre-setting.

**LOW1**

**LOW2**

- Ask your dealer or system operator for the output power level for each selection.

## TALK AROUND KEY

- TA** Turns the talk around function ON and OFF.
- The talk around function equalizes the transmit frequency to the receive frequency for mobile-to-mobile communication.

## EMERGENCY KEY

- EMER** Push and hold the key to transmit an emergency call.
- An emergency call is transmitted for a specified period after the “” appears.
  - If you want to cancel the emergency call, push (or push and hold) the key again before transmitting the call.
  - The emergency call is transmitted one time only or repeatedly until receiving a control code depending on the pre-setting.

## DTMF CHANNEL SELECT KEY

- DTMF** Push this key to select a DTMF channel.
- Push this key, then select the desired DTMF channel using the [CH UP] or [CH DN] key.
- Push and hold this key to transmit the selected DTMF code.

 **NOTE:** DTMF channels 6 and 7 are used for ID code and emergency code respectively, depending on your system. Ask your system operator or Dealer about DTMF channels 6 and 7 before using these DTMF.

## PUBLIC ADDRESS KEY

- PA** When an optional OPC-617 ACC CABLE is installed, the audio output via the cable can be controlled from the transceiver separately from the [VOLUME] control.
- This audio output can be used as a ‘public address’ function when an external audio amplifier and speaker are connected additionally.
  - Push this key, then speak into the microphone while pushing the PTT switch.
  - The [CH UP] and [CH DN] keys allow you to set the audio output level, from “,” (minimum) to “” (maximum).

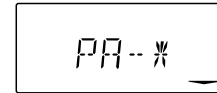

## EXTERNAL SPEAKER SWITCH

- SP** When external connections are made for the ‘public address’ function, the external speaker drive function is also available simultaneously. The received audio can be heard via the external speaker when this key is pushed.
- This function is useful when you are out of the vehicle.
  - The audio output level is linked to the transceiver’s volume control.

# 1 PANEL DESCRIPTION

## ■ Function display

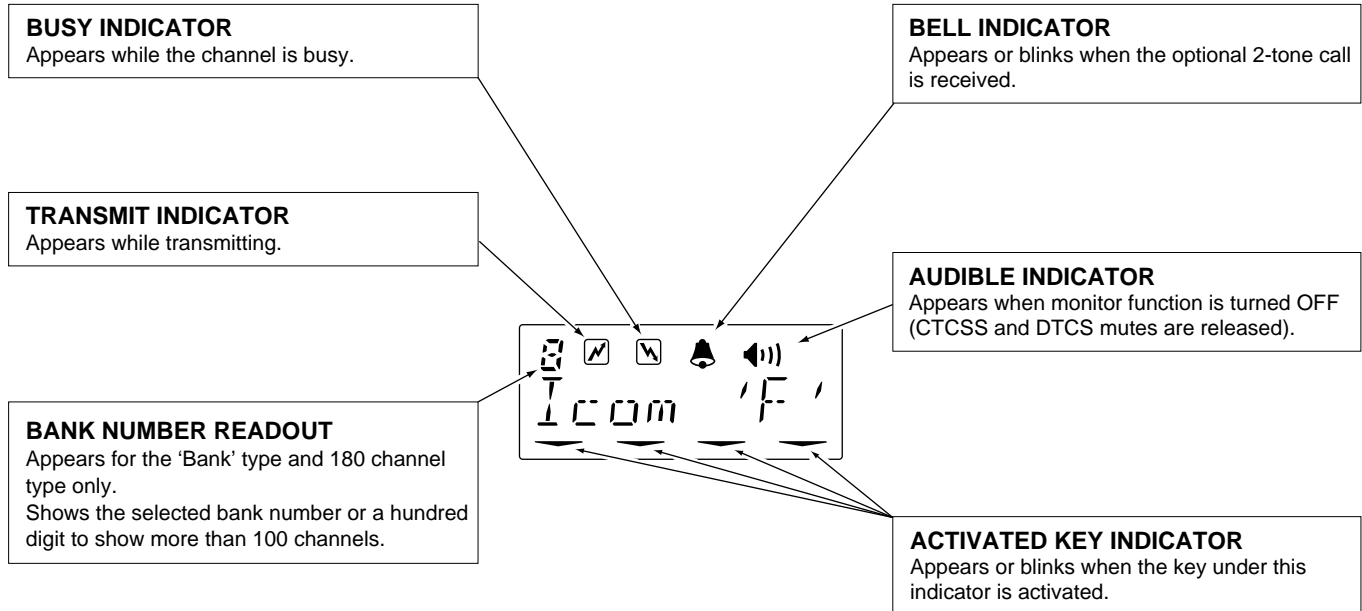



## ■ Turning power ON

① Push [Ⓜ] to turn the power ON.

- A power-up alert tone sounds for about 1 sec. and an opening message may appear.

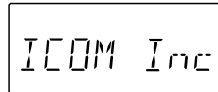

Opening message may differ depending on the pre-setting.

② If the transceiver is programmed for start up passcode, input digit codes as directed by your system operator.

- The following keys can be used for the password input:

The transceiver detects the numbers in the same block as the same number. Therefore the same effect for "1234" and "6789."

KEY	P <sub>0</sub>	P <sub>1</sub>	P <sub>2</sub>	P <sub>3</sub>	▽
NUMBER	0 5	1 6	2 7	3 8	4 9

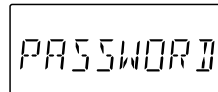

Input your password if this display appears.

③ When the "PASSWORD" indication does not clear after 4-digit input, the input code number may be incorrect. Turn power off and start over in this case.

## ■ Channel selection

There are several types available, and channel selection method may differ according to your system:

### **NON-BANK TYPE:**

Push the [CH UP] or [CH DN] keys to select the desired operating channel, in sequence; or, push one of the [CH 1] to [CH 4] keys to select these channels directly.

### **BANK-TYPE:**

① Push [BK S], then push [CH UP] or [CH DN] to select the desired bank number; or Push [BK UP] or [BK DN] if the transceiver has these keys.

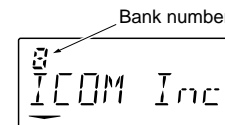

② Push [CH UP] or [CH DN] to select the desired channel in the selected bank.

### **AUTOMATIC SCAN TYPE:**

Channel setting is not necessary for this type. When turning the power ON, the transceiver automatically starts scanning. Scanning stops when receiving a call or taking the microphone off from the microphone hanger.

---



## 2 OPERATION

### ■ Receiving and transmitting

#### **RECEIVING:**

- ① Push [①] to turn the power ON.
- ② Push [CH UP] or [CH DN] to select a channel.
- ③ When receiving a signal, adjust the volume to a comfortable listening level.

#### **TRANSMITTING:**

- ④ Hung off the microphone from the microphone hanger:
  - CTCSS or DTCS may be released (“  - The channel is busy when “

 **IMPORTANT:** To maximize the readability of your signal: (1) pause briefly after pushing [PTT], (2) hold the transceiver 15 to 20 cm from your mouth, then speak into the microphone with normal voice level.

### ◇ Transmitting notes

#### • Transmit inhibit function

The transceiver has several lockout/inhibit functions which restricts the transmission under the following conditions:

- Channel is busy.
- Not matched (or matched) CTCSS or DTCS is receiving.
- The selected channel is a 'receive only' channel.

#### • Time-out timer

After continuous transmission for a pre-programmed period, the time-out timer is activated causing the transceiver to stop transmitting and automatically select receive.

#### • Penalty timer

Once the time-out timer is activated, transmission is further inhibited for a period determined by the penalty timer.

### ◇ DTMF transmission

If the transceiver has [DTMF] key, the automatic DTMF transmission function is available. Up to 7 DTMF channels may be available.

- ① Push [DTMF] to select the display as at right.
- ② Push [CH UP] or [CH DN] to select the desired DTMF channel.
- ③ Push and hold [DTMF] to transmit the DTMF code in the selected DTMF channel.

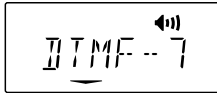

# 3

## CONNECTION AND INSTALLATION

### ■ Rear panel and connection

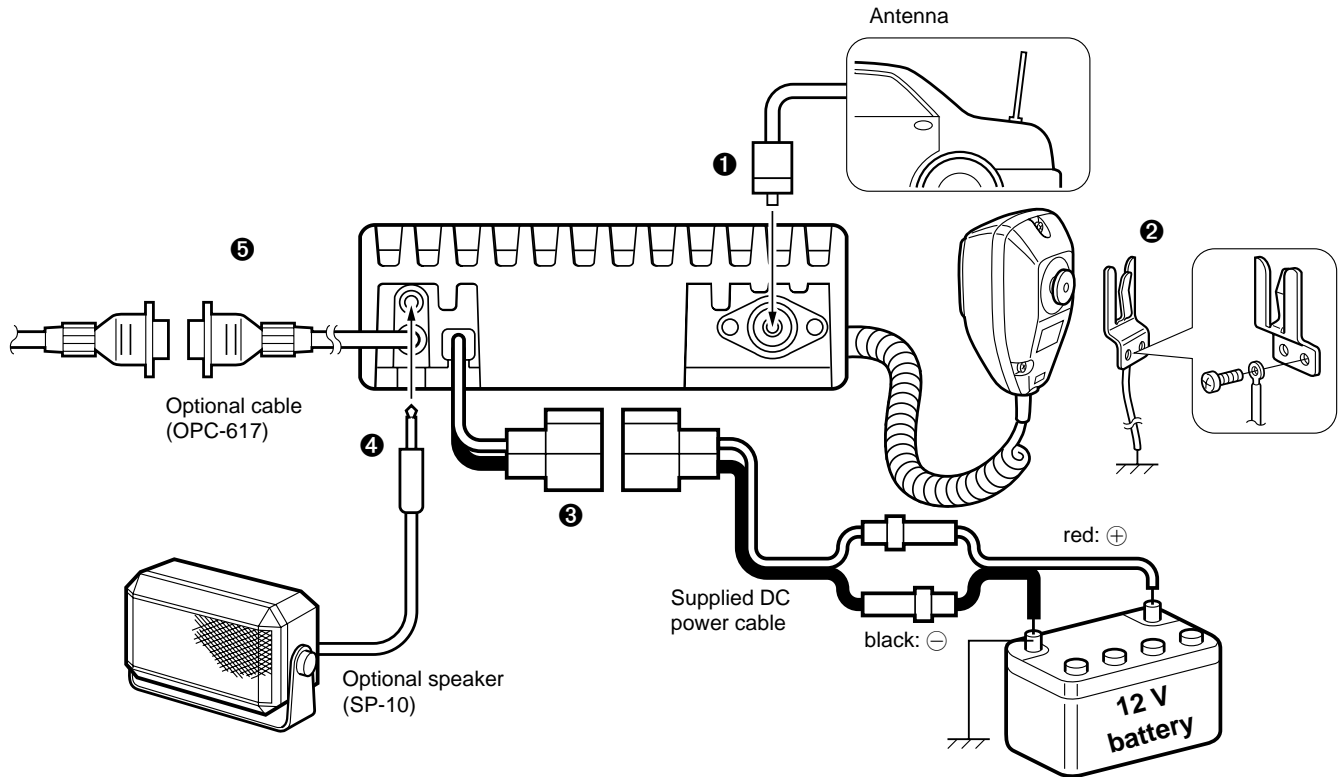

## ❶ ANTENNA CONNECTOR

Connects to an antenna. Ask your dealer about antenna selection and best installation location.

## ❷ MICROPHONE HANGER

Connect the supplied microphone hanger to the vehicle's ground for hanger function when hanging or releasing the microphone.

## ❸ DC POWER RECEPTACLE

Connects to a 12 V DC battery. Pay attention to polarities. **NEVER** connect to a 24 V battery. This could damage the transceiver.

## ❹ EXTERNAL SPEAKER JACK

Connect a 4–8 Ω external speaker, if desired.

## ❺ OPTIONAL CABLE (OPC-617)

Connect an external modem unit, LCD backlight control, audio amplifier for 'public address' function, etc.

## OPTIONAL CABLE PIN ASSIGNMENT

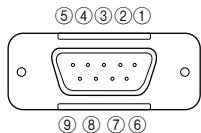

- |                        |               |                  |                        |
|------------------------|---------------|------------------|------------------------|
| ❶ LCD backlit cont. IN | ❹ Mod. IN     | ❺ PTT control IN | ❻ Horn drive cont. OUT |
| ❼ P-Address AF OUT     | ❼ Det. AF OUT | ❼ Mod. GND       | ❼ P-Address AF GND     |
| ❼ Det. AF OUT          | ❼ Det. AF GND |                  |                        |

## ■ Unpacking

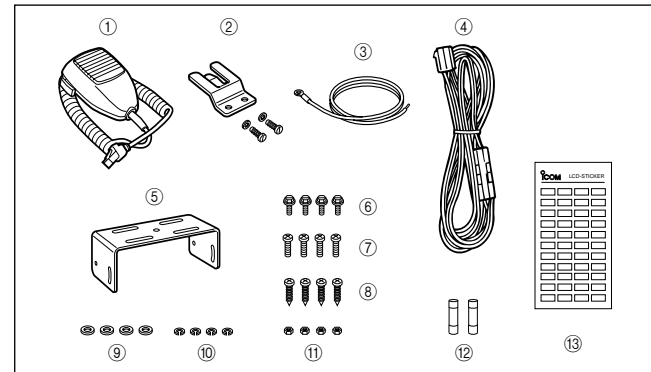

- |   |       |                                    |   |
|---|-------|------------------------------------|---|
| ❶ Microphone (EM-99) .....              | 1     | ❼ Mounting screw (M5x12) ...       | 4 |
| ❼ Microphone hanger and screw set ..... | 1 set | ❼ Self-tapping screw (M5x20) ..... | 4 |
| ❼ Microphone cable .....                | 1     | ❼ Flat washer .....                | 4 |
| ❼ DC power cable (OPC-345) .....        | 1     | ❼ Spring washer .....              | 4 |
| ❼ Mounting bracket .....                | 1     | ❼ Nut .....                        | 4 |
| ❼ Bracket bolt .....                    | 4     | ❼ Fuse (15 A) .....                | 2 |
|   |       | ❼ Function name sticker .....      | 1 |

## ◇ Function name sticker

There are no names on the programmable function keys since the needed functions can be assigned to these keys. Therefore, attach the supplied function name sticker on the “” indicator.

### 3 CONNECTION AND INSTALLATION

#### ■ Mounting

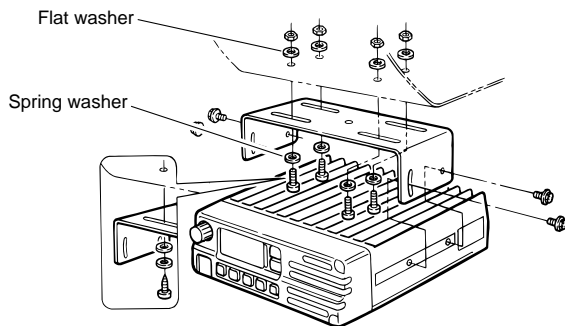

When using  
self-tapping screws

#### ■ Separation

- ① Separate the front panel from the transceiver main unit using an allen-wrench (1/32 in).
- ② Connect the optional separation cable to the both front and main unit attachments (fig. 1 and 2).
  - Remove the rear plate of the attachment.
  - Use the supplied screw to connect a cable lug.
  - For the main unit attachment, attach to the main unit using supplied screws, in advance.
- ③ Attach the front panel and attachment with the removed 3 allen socket bolts (fig. 3)

#### • Separation (using RMK-1)

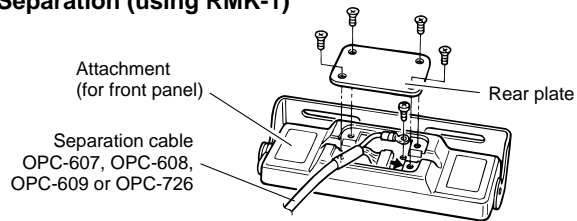

Fig. 1

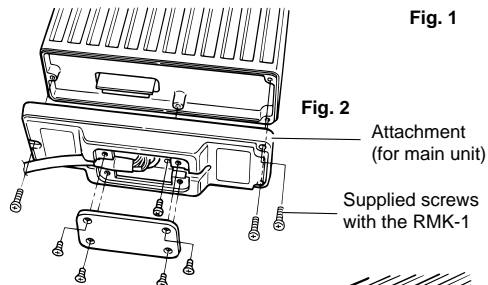

Fig. 2

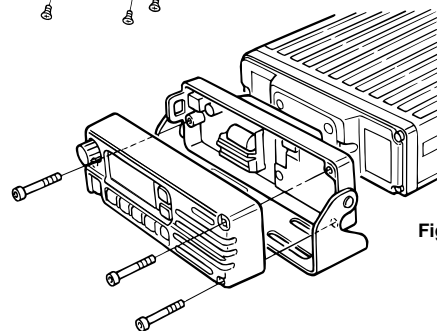
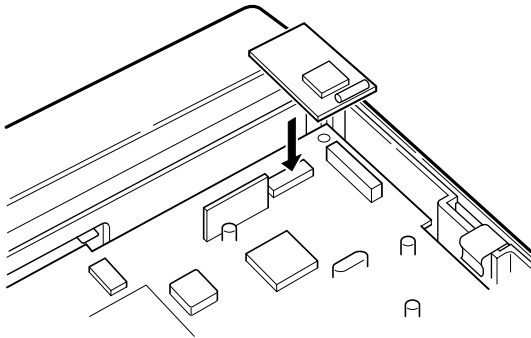

Fig. 3

## ■ Optional UT-105 installation

The optional UT-105 provides SmarTrunk II™ functions. Install the unit as follows:

- ① Turn power OFF, then disconnect the DC power cable.
- ② Unscrew the 4 screws, then remove the bottom cover.
- ③ Install the unit as shown in the diagram below.



- ④ Replace the bottom cover and screws, then the DC power cable.

**NOTE:** The sponge supplied with the UT-105 is for the IC-F30/F40 series transceivers only.

## ■ SmarTrunk II™ and conventional modes

This transceiver meets to SmarTrunk II™ functions.

The optional UT-105 allows communication in conventional channels or SmarTrunk II™ channels. Select a channel bank for SmarTrunk II™ before trunking operation.

- Push **[BK UP]** or **[BK DN]** one or more times to select a channel bank for conventional channels or SmarTrunk II™ channels.
- Pushing **[CH UP]** or **[CH DN]** while pushing **[BK S]** can also select the channel bank.
- Scanning starts when a channel bank for SmarTrunk II™ is selected.
- Contact your dealer for channel bank details.

 **NOTE:** Connect an optional DTMF microphone. Contact your dealer for details.

## ■ SmarTrunk II™ operation

These features are enabled by a dealer or system operator and may not be available in your system. Contact your dealer for details.

### ◇ Placing a telephone call

Enter the phone number followed by [1], [\*].

- A high-pitched beep indicates that the number is accepted.
- When the called party answers, push the [PTT] switch to talk, and release it to listen.

### ◇ Calling another local system subscriber

Enter the subscriber number followed by [3], [\*].

- A high-pitched beep indicates that the number is accepted.
- You hear ringing, then two short beeps when the subscriber answers.
- If the other subscriber is on another call or out of range, you hear a fast busy signal and the call terminates automatically.

### ◇ Receiving a call

When you hear ringing, push [\*] to answer.

- For a group call, you hear a short ring followed by two short beeps. You do not have to answer a group call to hear it over the air.



### ◇ Terminating a call

After completing a call, push [#] to disconnect (hang up).

 **IMPORTANT:** If one person in the conversation terminates a call, all participants will be cut off.

### ◇ Last number redial

Push [\*], [\*] to automatically redial the last number called.

- A high-pitched beep indicates that the number is accepted.

### ◇ Memory speed-dialing

To automatically dial a commonly used number from memory:

- Push [\*] followed by the memory location (0–9).

### ◇ Turbo Speedial

To automatically dial a commonly used number with one push:

- Push one of the turbo Speedials ([A], [B], [C] or [D]).

### ◇ Programming memory speed dial

- ① Push and hold [\*] until you hear a high-pitched beep.
- ② Enter the memory location (0–9, A, B, C, D), the telephone or subscriber number, then [1], [\*] (or [3], [\*] if for another system subscriber).
  - A high-pitched beep indicates successful programming.
  - Memories [A]–[D] are used for the Turbo Speedial.

### ◇ System busy indication

If all channels are busy, three low beeps sound after you initiate a call. Try the call again later.

### ◇ PTT dispatch operation

- ① Push [PTT] once (without dialing) to initiate a dispatch call.
- ② Begin talking after you hear three beeps (one short, high-pitched, two very-short, low-pitched).
- ③ Receiving a dispatch call is indicated by the same three-beep sequence.
  - It is not necessary to push [\*] to answer a dispatch call.

### ◇ Emergency call

Push [0], [\*] to initiate an emergency call.

- Contact your dealer for details.

---

## 4 OPTIONAL SmarTrunk II™ OPERATION

### ◇ **Clear channel alerting**

If all channels are busy, the transceiver automatically begins searching for an open channel and beeps every ten seconds. When two short beeps (low-pitched, then high-pitched) are heard, a channel is available. Push [ \* ], [ \* ] immediately to re-dial the last number.

 **NOTE:** For additional operating instructions, contact your dealer or system operator.

## EXTERNAL SPEAKERS

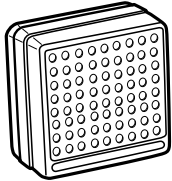

### SP-5

Large speaker for good audio quality.

Input impedance: 4 Ω

Max. input power: 5 W

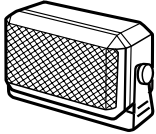

### SP-10

Compact and easy-to-install.

Input impedance: 4 Ω

Max. input power: 5 W

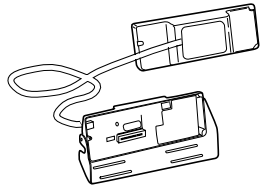

### RMK-1 SEPARATION KIT and SEPARATION CABLE

Allows you for separate installation of the transceiver main unit and front panel for easy installation and good operation convenience.

*SEPARATION CABLES:*

**OPC-607** (3 m), **OPC-608** (8 m)

**OPC-609** (1.9 m), **OPC-726** (5 m)

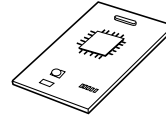

### UT-96 5-TONE DECODER UNIT

Provides for the 2-tone decode capability. The unit has 2 receive channels with easy PC programming.

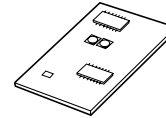

### UT-80 2-TONE DECODER UNIT

Provides for the 2-tone decode capability.

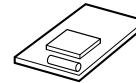

### UT-105 SmarTrunk II™ Logic Board

Provides for the SmarTrunk II™ capability.

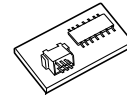

### EX-1761 MEMORY EXPANSION UNIT

Provides the 160 channels for large system operation.

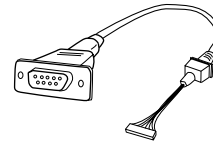

### OPC-617 ACC CABLE

Allows you to external terminal connection.

**Count on us!**

A-5441S-1US  
Printed in Japan  
Copyright © 1995 by Icom Inc.

**Icom Inc.**  
6-9-16 Kamihigashi, Hirano-ku, Osaka 547 Japan